



# LAGUNA

## 151-PFlux1

### IGM LAGUNA PFlux 1 Cyclone Dust Collector 230V

Manual



Producer

**Laguna Tools Inc.**

744 Refuge Way, Suite 200 Grand Prairie, Texas 75050  
USA

Phone: +1 800-234-1976

Website: [www.lagunatools.com](http://www.lagunatools.com)

Distributor

**IGM nástroje a stroje s.r.o.**

Ke Kopanině 560, 252 67, Tuchoměřice  
Czech Republic, EU

Phone: +420 220 950 910

E-mail: [sales@igmtools.com](mailto:sales@igmtools.com)

Website: [www.igmtools.com](http://www.igmtools.com)

2024-08-26

151-PFlux1 LAGUNA Cyclone Dust Collector Manual EN v4.01.00 A4ob  
VZOR\_Návod k obsluze STROJ EN v3.01.00



PDF ONLINE  
[www.igmtools.info](http://www.igmtools.info)



## **EN – English Manual**

Dear customer,

thank you for the confidence you have placed in us with the purchase of your new Laguna machine from IGM. This manual was prepared for the owner and operator of **IGM LAGUNA PFlux 1 Cyclone Dust Collector 230V** to promote safety during setup, operation and maintenance. Please read carefully and understand the information contained in this manual and accompanying documents. To obtain maximum service life and performance, use the machine according to these instructions and safety guidelines. Observe work safety.

We wish you a lot of work satisfaction and joy when working with the IGM LAGUNA PFlux 1 Cyclone Dust Collector 230V.

### **Contents**

1. Declaration of Conformity
  - 1.1 Warranty
2. Product Specifications
3. Safety
  - 3.1 Intended Use
  - 3.2 General Safety Instructions
  - 3.3 Symbols
  - 3.4 Additional Instructions for Dust Collectors
  - 3.5 Power Supply
  - 3.6 Environment
4. Machine Description
  - 4.1 Package Contents
  - 4.2 Parts Description
5. Setup
  - 5.1 Unpacking
  - 5.2 Assembly
  - 5.3 Operation
6. Maintenance and Inspection
  - 6.1 Emptying the Drum
  - 6.2 Emptying the Filter End Cap
  - 6.3 Cleaning the HEPA Filter
  - 6.4 Replacing the HEPA Filter
7. Accessories
8. Troubleshooting
9. Wiring
10. Parts List

## 1. Declaration of Conformity



### EC DECLARATION OF CONFORMITY

According to the following EC Directives

- Machinery Directive: 2006/42/EC
- Low Voltage Directive: 2014/35/EU



**The applicant: LAGUNA TOOLS, INC./ 744 Refuge Way, Suite 200, Grand Prairie, Texas 75050 USA**

**Manufacturer: SAN FORD MACHINERY CO., LTD./ No.169, Chung shan Rd., FengYuan Dist., Taichung City 420, Taiwan (R.O.C.), Taiwan, manufacturer, declares that the machine described hereafter:**

#### **DUST COLLECTOR MODEL:**

***BFLUX1, CFLUX1, PFLUX1, CFLUX2, PFLUX2, CFLUX3, PFLUX3, TFLUX5, TFLUX10, XFLUX10, SFLUX10, AFLUX12, 820680, 821200***

Provided that it is used and maintained in accordance with the generally accepted codes of good practice and the recommendations of the instructions manual, meets the essential safety and health requirements of the Machinery Directive.

The person who compile technical file established within the EU:

Name: IGM nastroje a stroje s.r.o.

Address: Ke Kopanine 560, Tuchomerice, CZ-252 67

Tel.: +420 220 950 910

Email: [sales@igmttools.com](mailto:sales@igmttools.com)

**The TCF (No. SF-2024003-A1) is archived by CEPROM S.A. located in Str. Fântânele f.n., 440240 Satu Mare, judetul Satu Mare, Romania.**

For the most specific risks of this machine, safety and compliance with the essential requirements of the Directive has been based on elements of:

- **EN ISO 12100:2010 / Safety of machinery - General principles for design - Risk assessment and risk reduction (ISO 12100:2010)**
- **EN 60204-1:2018 / Safety of machinery - Electrical equipment of machines- Part 1: General requirements- Industrial electrical device.**



Date: May 20, 2024

Authorized Signature:

Position: Chief Executive Officer

Place: Laguna Tools Inc.

744 Refuge Way, Suite 200, Grand Prairie, Texas 75050, USA

## 1.1 Warranty

IGM always strives to deliver a high-quality and efficient product. The warranty is governed by the valid terms and conditions of IGM.

## 2. Product Specifications

Machine Dimensions (LxWxH):	1168 x 610 x 1753 mm
Machine Weight:	122 kg
Package Dimensions (LxWxH):	1150 x 760 x 1350 mm
Package Weight:	155 kg
Noise Level:	70 dB
Motor:	1100 W
Power:	230 V / 50 Hz / 1 Phase
Recommended Breaker:	16 A, tripping characteristic C (16/1/C)
Airflow (traditional method):	1786 m3/hour (1051 CFM)
Airflow (realistic method):	1224 m3/hour (720 CFM)
Max. Static Pressure:	2514 Pa
Fan Diameter:	340 mm
Inlet Diameter:	1x 150 mm or 2x 100 mm
Switch:	High-frequency remote control switch
Drum Volume:	95 l
Filter:	HEPA - 99.2 % of particles over 0,4 microns
Filtered Area:	945 m2
Filter Dimensions:	diameter 400 mm x height 500 mm
Drum Waste Bag:	1090 x 810 mm

## 3. Safety

Proper use includes compliance with the instructions given in this manual and general regulations applicable in your country. The operator is liable for any use in violation of the intended use.

### 3.1 Intended Use

The machine is designed for collecting chips and sawdust from wood and woodworking machines. Collection of any other materials is prohibited.







### 3.2 General Safety Instructions

**Warning!** Read all instructions and safety guidelines. Failure to follow safety instructions may result in damage to the machine and serious injury to the operator. Keep the manual for future reference.

- The machine may be dangerous if not used properly.
- The machine may be operated only by a person familiar with the contents of this manual and machine operation.
- Keep children and pets away from packaging materials supplied with this machine.
- Place the machine on a stable and well-lit surface. There must be sufficient space around the machine for safe operation.
- Check the technical condition of the machine before operation. The machine may be used only in a perfect technical condition. If you notice any defects, do not start the machine and have it repaired by a qualified person.
- Replace damaged parts immediately. Use only original spare parts.
- All safety covers must be mounted before operation. Replace damaged covers immediately.
- The machine may be used, assembled, and maintained only by persons familiar with its operation and aware of potential danger. No changes to the machine may be made!
- Carry out maintenance regularly.
- Keep the machine and the surrounding area clean and well-lit. Remove all tools from the machine and surroundings before starting the machine.
- Carry out assembly, repairs and maintenance only when the machine is disconnected from the power supply.
- Prevent unintentional start of the machine. Before connecting the machine to the power supply, make sure the switch is in the OFF position.
- Make sure the circuit requirements specified in this manual are met.
- Take care of your safety when operating the machine. Long hair, loose clothing and jewellery may cause injury. Wear suitable work clothing, footwear, head, eye, ear and respiratory protection.
- Do not use gloves when operating the machine.
- Do not operate the machine if you are tired, ill or under the influence of drugs or alcohol.
- Watch your hands and fingers. Always use both hands when working.
- Do not lean over the machine. Always maintain balance and stand on a firm and stable surface when working.
- Keep children and other persons from moving freely around the workplace. Keep the machine out of reach of children and unqualified persons. Do not allow anyone unfamiliar with the machine and this manual to operate the machine.

- Never leave a running machine unattended. After you finish your work, turn off the machine and disconnect it from the power supply.
- Do not leave the machine in a damp environment and do not expose it to rain.
- Do not overload the machine.
- Do not operate the machine near flammable liquids or gases.
- Keep the motor fan clear.

### 3.3 Symbols

	Read the manual and all instructions carefully before use.
	Wear head, ear, eye and respiratory protection.
	Disconnect the machine from the power supply.
	Scan the QR code to find the manual.
	CE mark: The product is in compliance with EEA directives.
	Do not dispose of the appliance in the municipal waste.
	Recycle package materials.

### 3.4 Additional Instructions for Dust Collectors

**Caution!** Dust containing harmful chemicals such as lead from lead-based paints or arsenic and chromium from chemically treated lumber can be produced during operation. Work in a well-ventilated area and wear approved protective equipment. Observe safety regulations applicable in your country.

- Wear eye and respiratory protection when operating and maintaining the machine.
- Dispose of waste (dust and chips) following local regulations applicable in your country.
- Make sure the casters are locked before turning the machine on.
- Do not place your hands or tools near the air intake.
- Collect intended material only. If you accidentally use wood containing metal scraps (nails, staples etc.), stop working and turn the machine off immediately. Empty the drum (bag) and check the condition of the machine.
- Regularly check the waste level in the drum (bag). Empty if necessary.

### 3.5 Power Supply

**Warning!** Any modification to the electrical installation may be carried out only by a qualified electrician in accordance with all applicable regulations.

**Warning!** Do not connect the machine to the power supply until it is ready for operation.



#### Circuit Requirements

**Warning!** These requirements apply to a dedicated circuit where only one machine runs at a time. Consult a qualified electrician before connecting the machine to a shared circuit. Make sure the circuit is properly sized for safe operation.

This machine is designed to operate on a grounded power supply. The power circuit includes all electrical appliances between the machine and the breaker box or fuse panel in the building. The power circuit used for this machine must be sized to safely handle a full load current for an extended time.

#### Grounding and Plug Requirements

**Caution!** Improper grounding and connection of the machine to the power supply may result in an electric shock, damage or fire.

This machine is equipped with a grounded power cord. Insert the plug only into a matching outlet that is properly installed and grounded in accordance with all local regulations. Do not modify the provided plug!

Do not use the machine if the power cord or plug is damaged. All repairs may be carried out only by a qualified electrician!

### 3.6 Environment

Do not dispose of the appliance in the municipal waste. Electronic appliances must be collected and handed in for proper recycling. Recycle package material and other accessories. Observe safety regulations applicable in your country.



## 4. Machine Description

Carefully observe the images below and familiarize yourself with the package contents and listed machine parts and features.

### 4.1 Package Contents

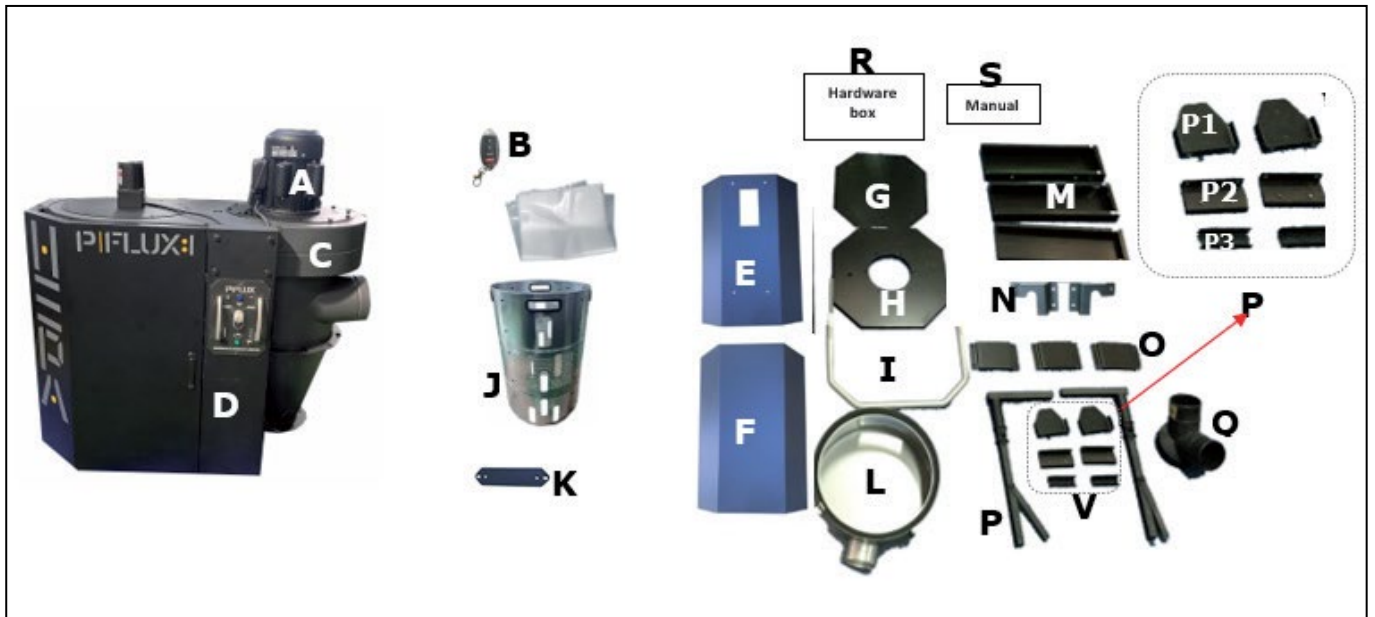

- A. Motor
- B. Remote control
- C. Dust chute
- D. Top upright supports (3x)
- E. Front drum panel
- F. Back drum panel
- G. Drum base
- H. Drum lid
- I. Handle for drum lifting
- J. Drum insert
- K. Crossbar
- L. Filter end cap
- M. Lower upright supports (3x)
- N. Drum side plate (left and right)
- O. Upright support reinforcement plate (3x)
- P. Right and left bar for lifting mechanism
- P1. Lower triangular support plate (2x)
- P2. Lifting mechanism support (2x)
- P3. Lower cover plate (2x)
- Q. Inlet adaptor (2 openings)
- R. Hardware
- S. Manual

### 4.2 Parts Description

#### Control panel

- A. HEPA filter detection  
Illuminates when filter cleans (automatic cleaning/manual activation).

**B. Drum illumination switch**

Controls the LED light on the drum lid to illuminate inside the drum for visuals of the dust level.

**C. Control panel pair button**

Used to pair remote control with the machine.

**D. Full drum detection**

When the drum is full, the machine beeps continuously and the indicator light illuminates. When the drum is close to 70-80% full, the machine beeps intermittently.

**E. ON/OFF switch**

Turns the collector on or off.

**F. On board circuit breaker**

Pops out if the machine is overloaded. Allow the machine to cool down for a few minutes. Then press the reset button.

**G. Manual activation**

Press for 3 seconds to activate cleaning while the collector is ON. You can also activate this function by pressing the CLEAN button on the remote for 3 seconds.

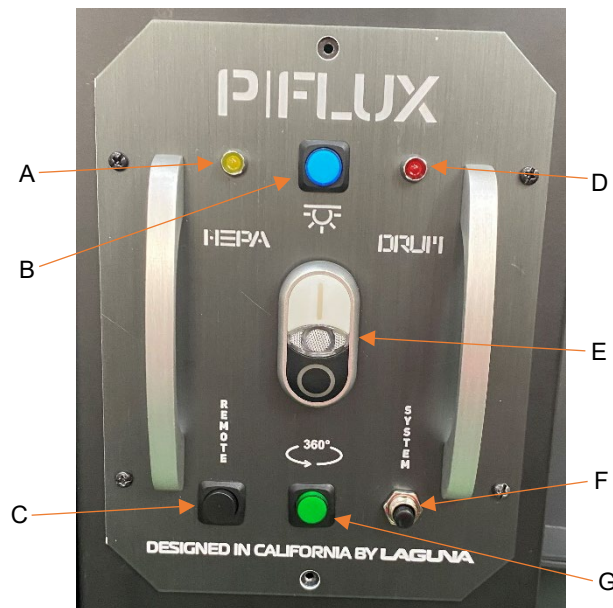

**Remote control**

The remote control requires a 12V battery type 27A.

**A. ON button**

**B. OFF button**

**C. CLEAN button (PFlux only)**

**D. Remote control pair button**

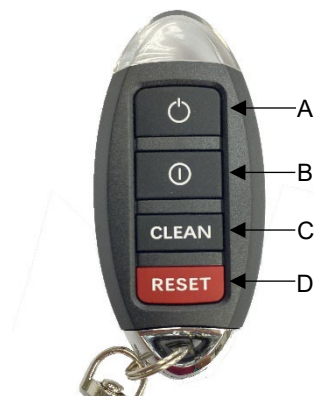

**Pairing remote control**

1. Ensure the machine is ON before pairing the remote control.

2. Press the control panel pair button until you hear two beeps.

3. Press the remote control pair button simultaneously with the control panel pair button until you hear three beeps. The remote control is now paired.



Pairing more remote controls

You can pair up to 5 remotes to one machine. Each remote must be paired separately. If you pair a sixth remote to the machine, the first paired remote will be disconnected and replaced by the sixth remote. This also applies to the next remotes.

## 5. Setup

Approximate assembly and setup time: 4-5 hours

### 5.1 Unpacking

When unpacking, separate the machine and all supplied parts from the packaging materials. Check that no parts have been damaged. If damage has occurred as a result of transport, contact your supplier immediately.

been damaged. If damage has occurred as a result of transport, contact your supplier immediately.

The dust collector is supplied in a single box. Two persons are required to remove the machine from the box! The collector is heavy, be careful when lifting and moving.

1. Carefully cut the banding straps.
2. Cut along the tape line at the top of the box.
3. Remove all parts from the top of the polystyrene and set aside.
4. Remove the polystyrene packing material from the top of the machine.
5. Carefully take out the machine components from the box and set aside.
6. Check all parts according to package contents.

### 5.2 Assembly

- **Required tools (not included):**
  - Open-end wrench – 10 mm; 12 mm; 14 mm
  - Phillips screwdriver
  - Allen key – 4 mm; 5 mm
  - Silicone

Step 1: With the help of another person, remove the dust chute from the package. Turn it upside down and place it in the polystyrene packing.



Step 2: Remove base frame that is bolted to (3x) top upright supports. Keep (6x) 3/8"x3/4" bolts and (6x) 3/8" washers.

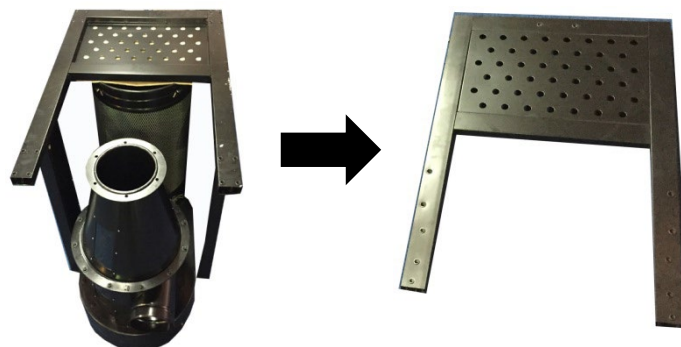



Step 3: Turn the base frame upside down. Prepare (16x) 5/16 "x3/4" bolts and (16x) 5/16" washers. Install two casters with brakes (B) to the part of the base with the drum opening and the other two casters (A) on the opposite side of the base.



Step 4: Turn the base over with it standing on the casters. Mount the (3x) lower upright supports (top of triangles pointing inside) to the base using (6x) 3/8"x3/4" bolts and (6x) 3/8"x7/8" flat washers.

- A - mount the support with one triangle on the filter side.
- B - mount the support with two triangles on the front side.
- C - mount the support with three triangles on the opposite side.

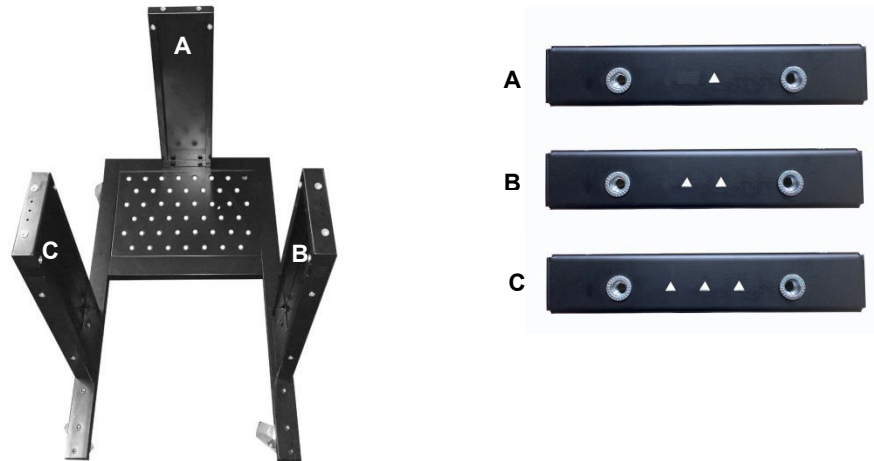

Step 5: Secure the base with lower upright support panels to the dust chute. Make sure the top and lower supports match. Use (6x) 5/16"x3/4" bolts and (6x) washers to connect the top and lower supports.



Step 6: Secure (3x) upright support reinforcement plates where the top and lower upright supports meet using (12x) 5/16 "x3/4" bolts and (12x) 5/16" washers.

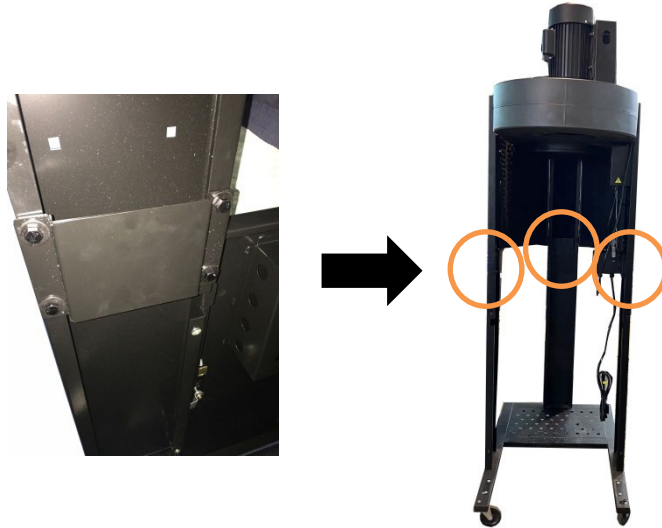

Step 7: With the help of another person, turn the collector over with it standing on the casters.

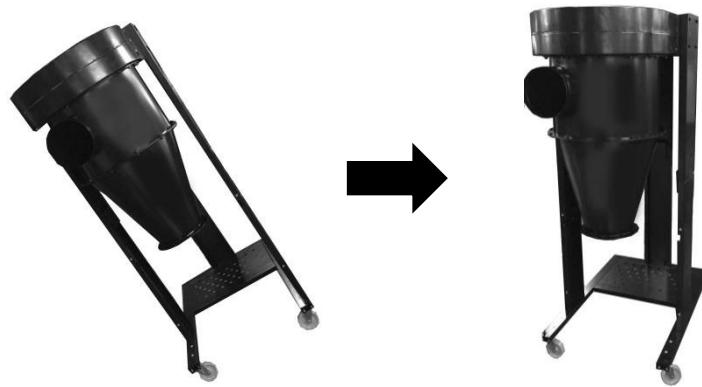

Step 8: Attach the filter end cap to the HEPA filter using the (4x) latches. Cover the opening with a rubber plug.



Step 9: Secure the lower triangular support plate to the base using (2x) 5/16"x3/4" bolts and (2x) 5/16" washers. Follow the same steps for the opposite side.

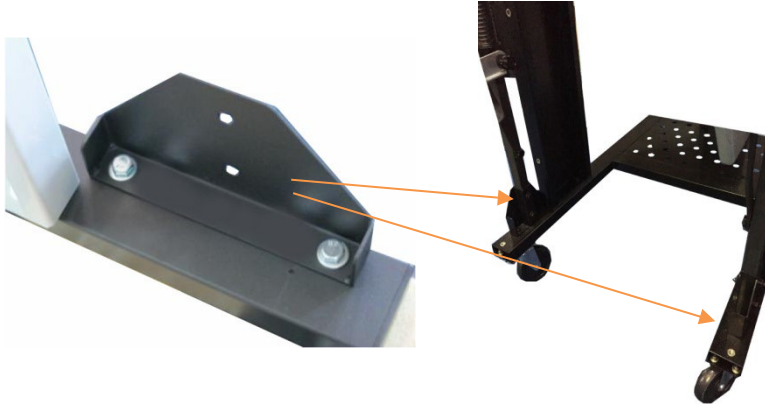

Step 10: Secure the lifting mechanism support to the lower upright support using (2x) 5/16"x1/2" bolts, (2x) 5/16" washers and (2x) 5/16" nuts.



Step 11: Find the left (A) and right (B) bar for lifting mechanism. To identify the correct side, look for the protruding nut. It should be facing upwards when you place the bars on the floor.

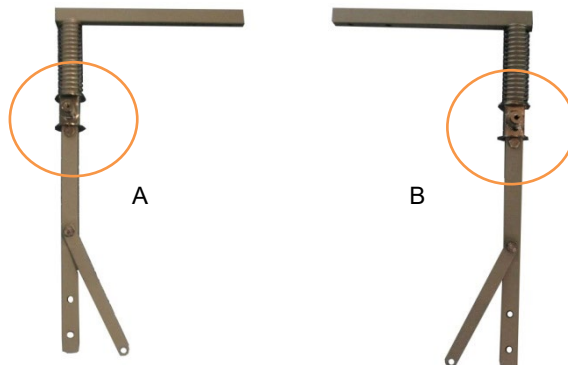

Step 12: Slide the bar into the opening on the lower upright support. Ensure that the bottom end is inserted in the lower triangular support plate. Follow the same steps for the opposite side.



Step 13: Make sure the bar is pushed all the way into the opening on the lower upright support. Secure the bar using (4x) 5/16"x1-3/4" bolts, (8x) 5/16" washers and (4x) 5/16" nuts. Follow the same steps for the opposite side.

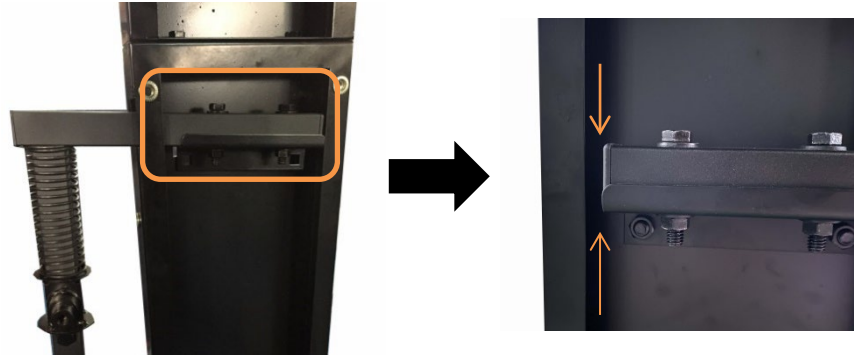

Step 14: Secure the bar to the triangular support plate using (2x) 5/16"x1-3/4" bolts, (4x) 5/16" washers and (2x) 5/16" nuts so that the bolt head is on the inside. Follow the same steps for the opposite side.



Step 15: Cover the lifting mechanism with lower cover plates. Secure using (6x) 1/4"x3/4" hex bolts and (6x) 1/4" washers. Follow the same steps for the opposite side.

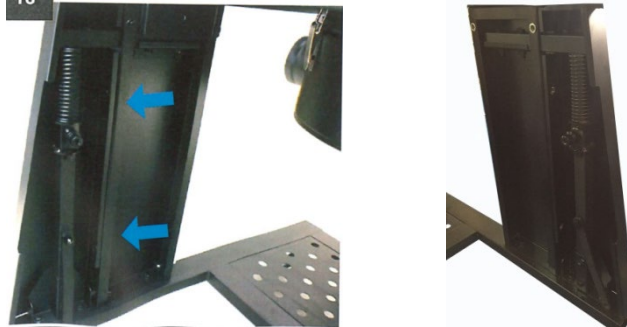

Step 16: Attach both ends of the handle for lifting drum to the nut of the lifting mechanism.

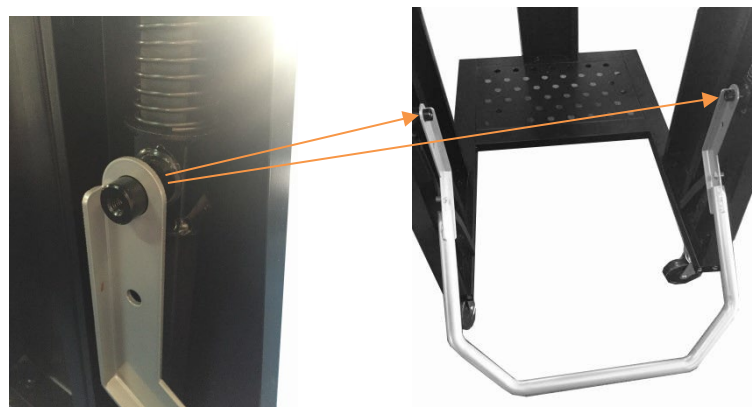

Step 17: Secure with cover. Cover is attached using (1x) M8x30 mm bolt. Follow this step on the opposite side.



Step 18: Secure the bar to the handle using (2x) 3/8"x21mm bolts and 3/8" nuts. Make sure the bolt head is on the inside of the handle (A). Adjust the tightness of this bolt accordingly. If this bolt is too tight, the lifting mechanism will not work smoothly. When too loose it will not pick up the drum.



Step 19: Attach the drum lid to the cyclone funnel with applied foam tape using (6x) 5/16"x3/4" bolts, (12x) 5/16" washers and (6x) 5/16" nuts. On the funnel you will find the following label:

**ATTENTION!** Do not tighten the (8x) bolts that mount the cyclone funnel to the drum lid. First, perfectly align the drum lid parallel to the upright supports. The drum lid can be swivelled about 30 degrees +/- . Failure to do so will make the drum poorly sealed and unable to fit between supports. Remove this label after completing this step.



○

**ATTENTION**

Do not tighten the 8 X bolts that mounts to cone flange to top of drum lid until you have perfectly aligned the drum lid up parallel to the uprights.

This ingenious design allows you to swivel the drum lid about 30 degrees +/-

Failure to do so will make the drum unable to fit in space between vertical uprights.

Step 20: Attach the full drum detection sensor to the opening on the drum lid located behind the cyclone funnel. When securing the sensor make sure the end of the sensor (A) is not longer than the drum lid rim (B). If it extends past the rim, the detection will not function correctly.



Step 21 Attach the LED light to the drum lid using (6x) M4\*10mm bolts, (6x) 3/16" washers and (6x) M4 nuts.

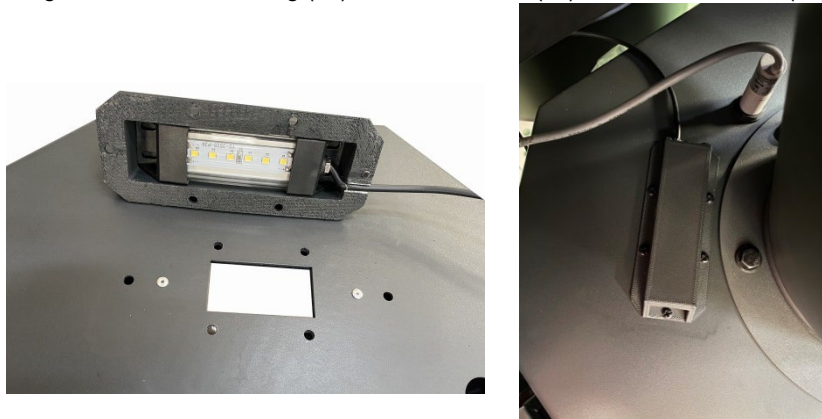

Step 22: Attach the crossbar to the drum lid and tighten using (2x) 5/16"x3/4" bolts, (4x) 5/16" washers and (2x) 5/16" nuts. It does not matter which position you attach the crossbar.

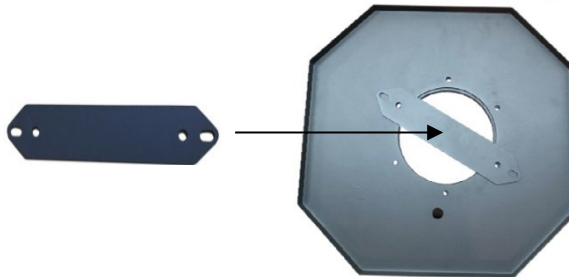

Step 23: Assemble the drum. Find the drum base panel and secure the (4x) casters using (16x) 5/16"x3/4" bolts, (32x) 5/16" washers and (16x) 5/16" nuts.

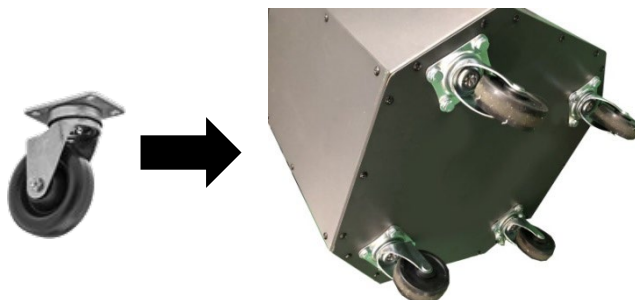



Step 24: Attach the handles to the top and bottom end on the front drum panel using (4x) 5/16"x3/4" bolts, (4x) 5/16" washers and (4x) 5/16" nuts. Note that the head of the bolt must be inserted from the handle with the nut and washer on the inside of the drum.



Step 25: Assemble front and back drum panel using (12x) M4x12mm sheet metal screws.

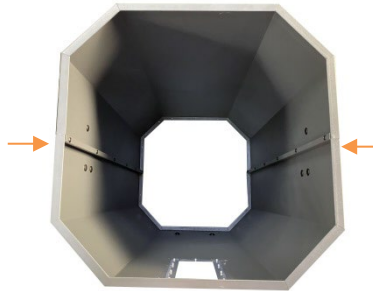

Step 26: On the left and right side of the drum you will find three bolt holes. Secure the matching side plate to the drum panel using (6x) 1/4"x1/2" bolts, (6x) 1/4" washers and (6x) 1/4" nuts. Insert the head of the bolt from the inside of the drum with the washers and nuts on the outside of the drum.

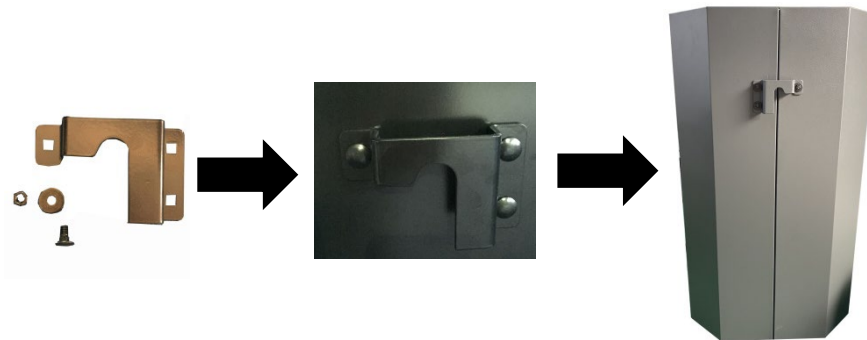

Step 27: Lay the drum on its side. With the help of another person, align the drum with the base with attached casters. Using (22x) M4 sheet metal screws fasten tightly.





Step 28: (22x) Cover all (22x) screws with (22x) plastic caps.



Step 29: Once assembly is complete, apply silicone (not included) to the top and bottom rim inside the drum. This will seal the drum and prevent any leaks.

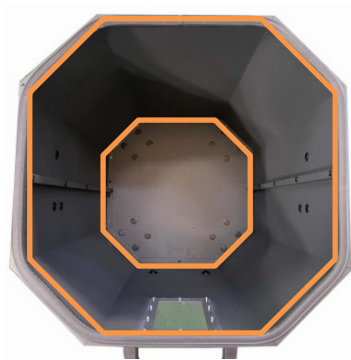

Step 30: Attach the rubber gasket to the top rim of the drum. Remove excess rubber gasket.

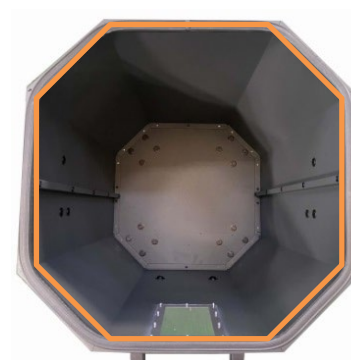

Step 31: Insert waste bag in the drum. Spread the bag all over the drum.



Step 32: Use (24x) 3/16"x1/2" bolts and (24x) 3/16" nuts to assemble the drum insert. Place the drum insert inside over the plastic bag.

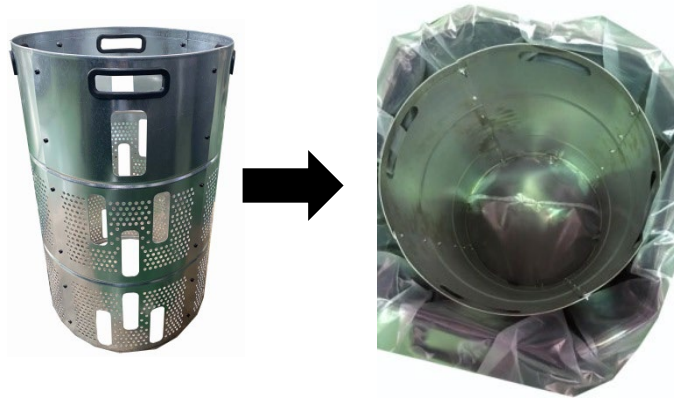

Step 33 Lift the bar. Push the drum in and align. Lower the bar to seal the drum tight for normal machine operation.



Step 34: Make sure when aligning the drum that both the left and right side plates are seated in the lifting mechanism (A). When aligned incorrectly (B), the drum will not be fully sealed and will interfere with the airflow.

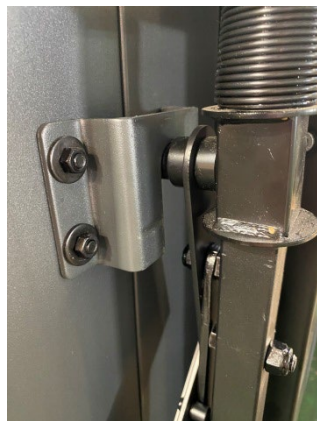

A



B

Step 35: With the white plastic pin, you can adjust the detection rate of a full drum. Insert the tip of the pin into the top end of the sensor.

Turn clockwise to lower the full detection rate (less waste in the drum).

Turn counterclockwise to increase the full detection rate (more waste in the drum).



Step 36: Install the inlet adaptor with 2 openings using (3x) M4x12mm sheet metal screws. Attach the rubber caps to each opening. Assembly is now completed.

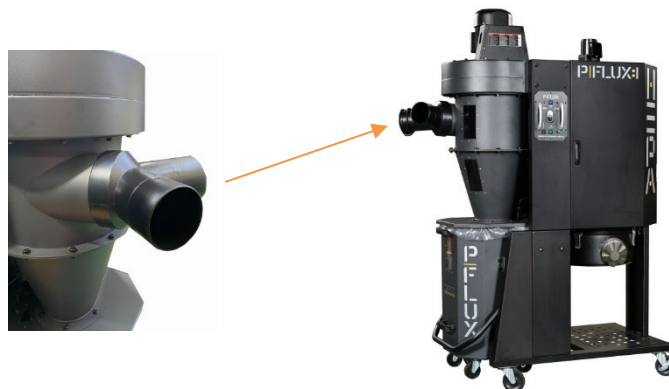

### 5.3 Operation

1. Remove the rubber cap from the connected opening. Check all parts of a dust collection system to ensure sufficient airflow.

**Warning!** Do not turn the collector on when all blast gates are closed!

2. Confirm that the power supply is connected correctly and without damage.

3. Check the surroundings. Do not carry out any repairs or maintenance on the machine when in use!

4. To start, press the ON button on either the control panel or paired remote control.

5. To stop, press the OFF button on either the control panel or paired remote control.

### 6. Maintenance and Inspection

**Caution!** Disconnect the machine from the power supply before maintenance and inspection. Carry out maintenance regularly.

**Before each use**, check for loose or damaged parts and whether the cord is worn out or damaged. Do not use the machine until all defects have been fixed. **After each use**, clean dust and other waste from the machine and surrounding area. Wipe the machine using a dry cloth.

**Carry out the following tasks regularly:**

- Check for leaks.
- Clean the filter and its parts.

#### 6.1 Emptying the Drum

Periodically inspect the contents of the drum and empty as needed. To inspect the contents of the drum, check the full drum detection, look through the window or remove the drum.

1. Raise the handle for lifting drum to lower the drum on the floor.

2. Slide the drum out of the machine, check and empty as needed.

#### 6.2 Emptying the Filter End Cap

Periodically inspect the filter end cap. If it is more than one third full, empty it. If the filter end cap gets too full, dust can be pulled back into the filter. This restricts airflow and can expose you to harmful particles.

1. Release the (4x) latches around the filter end cap and remove it.
2. Empty the cap and reattach using latches.

### 6.3 Cleaning the HEPA Filter

The HEPA filter automatically cleans every 10 minutes for 10 seconds clockwise and 10 seconds counterclockwise. Automatic cleaning also starts whenever you turn the machine off. While the filter is being cleaned, the yellow LED light for HEPA filter detection illuminates on the control panel.

The yellow LED light for HEPA filter detection can also flash in one long and two short intervals if the HEPA filter needs to be replaced.

For heavy duty users, it is recommended to use compressed air regularly to maintain maximum filtration efficiency and longer service life.

1. Empty the filter end cap.
2. Open both filter shields. Connect an extraction hose from the inlet adaptor to the filter end cap.
3. Turn the machine on and leave it running.
4. Use compressed air to blow the filter from the outside.
5. Turn the machine off and empty the filter end cap.

### 6.4 Replacing the HEPA Filter

To maintain good air quality in your workshop and to ensure proper filtration, the HEPA filter should be replaced after approximately 2000 hours of operation (8 hours/day x 250 days = 2000 hours). Please contact your supplier for HEPA filter replacement.

To replace the HEPA filter, follow the steps below. Disconnect the machine from the power supply!



1. Release the (4x) latches around the filter end cap and set it aside.
2. Remove the rotation shaft bolt from the bottom of the shaft using a 12 mm wrench. Remove (4x) bolts connecting the bottom part to the filter.
3. Slide the shaft out and set all components aside.
4. Open filter shields and release the band clamp at the top of the filter. Support the filter from the bottom.
5. Remove and replace the HEPA filter. To install a new HEPA filter, repeat the steps above in reverse.
6. After replacing HEPA filter, press the remote control pair button five times. The LED indicator is now reset to zero.

### 7. Accessories

Recommended accessories is listed on the IGM website.

**Caution!** Installing unapproved accessories may cause damage to the machine and serious injury. Use only accessories recommended for this machine by IGM.

### 8. Troubleshooting

<p><b>Machine does not start or a breaker trips.</b> Possible Cause:</p> <ol style="list-style-type: none"> <li>1) Power supply is turned OFF or faulty.</li> <li>2) Wall fuse/circuit breaker is blown/tripped.</li> <li>3) Faulty remote control.</li> <li>4) Remote receiver is faulty.</li> <li>5) Incorrectly wired motor connection.</li> <li>6) On-board circuit breaker is tripped.</li> <li>7) Wiring is open/has high resistance.</li> <li>8) Faulty power switch.</li> <li>9) Faulty switch. Motor is at fault.</li> </ol>	<p>Possible Solution:</p> <ol style="list-style-type: none"> <li>1) Ensure power supply is ON and has the correct voltage.</li> <li>2) Ensure adequate circuit size, reset breaker.</li> <li>3) Replace batteries; ensure unobstructed line of sight and signal range.</li> <li>4) Inspect receiver circuit board; replace if faulty.</li> <li>5) Rewire or call certified service technician or electrician.</li> <li>6) Allow motor to cool, improve ventilation, press reset button.</li> <li>7) Check for broken wires or poor connections, repair as necessary.</li> <li>8) Replace switch.</li> <li>9) Test/repair/replace.</li> </ol>
<p><b>Excessive vibration or noise during operation.</b> Possible Cause:</p> <ol style="list-style-type: none"> <li>1) Loose component.</li> <li>2) Loose or broken motor mount.</li> <li>3) Motor fan hitting fan cover.</li> <li>4) Bad motor bearings.</li> </ol>	<p>Possible Solution:</p> <ol style="list-style-type: none"> <li>1) Inspect and tighten all bolts/nuts.</li> <li>2) Tighten or replace as needed.</li> <li>3) Check fan and cover; replace as needed.</li> <li>4) Rotate shaft manually, check for grinding or loose shaft, replace bearings if needed.</li> </ol>
<p><b>Loud or repetitive noise, excessive vibration coming from machine.</b> Possible Cause:</p> <ol style="list-style-type: none"> <li>1) Machine is on uneven surface.</li> <li>2) Damaged/Unbalanced fan.</li> <li>3) Loose connections.</li> <li>4) Fan is loose.</li> <li>5) Motor fan hitting fan cover.</li> </ol>	<p>Possible Solution:</p> <ol style="list-style-type: none"> <li>1) Stabilize on a flat surface.</li> <li>2) Inspect fan for dents, bends, or other damage.</li> <li>3) Check and re-tighten all fasteners.</li> <li>4) Replace the motor and fan.</li> <li>5) Check fan and cover; replace as needed.</li> </ol>

<p><b>Cyclone collector does not adequately collect dust or chips; poor performance.</b> Possible Cause:</p> <ol style="list-style-type: none"> <li>1) Drum or filter end cap are full. Filter is dirty.</li> <li>2) Clogged dust collection.</li> <li>3) Dust collection is too long or has too many sharp bends.</li> <li>4) Wet lumber is clogging collection.</li> <li>5) Leaks in the dust collection or too many open blast gates.</li> <li>6) Inadequate velocity in the main collection line.</li> <li>7) Wrong size ducting/ports used.</li> </ol>	<p>Possible Solution:</p> <ol style="list-style-type: none"> <li>1) Empty drum and filter end cap. Clean filter.</li> <li>2) Clean inlet adaptor.</li> <li>3) Move the machine closer to the point of collection. Rerun ducts to eliminate sharp bends.</li> <li>4) Use lumber with less than 20 % moisture content.</li> <li>5) Repair all leaks and close any gates not being used.</li> <li>6) Increase velocity by opening 1 or 2 more blast gates to different branch lines.</li> <li>7) Re-size and re-install ducts and fittings.</li> </ol>
<p><b>Sawdust being blown into the air from the cyclone collector.</b> Possible Cause:</p> <ol style="list-style-type: none"> <li>1) Band clamps are not secure.</li> <li>2) Loose or damaged seals.</li> </ol>	<p>Possible Solution:</p> <ol style="list-style-type: none"> <li>1) Re-install ensuring a tight fit.</li> <li>2) Replace seals and gaskets.</li> </ol>

## 9. Wiring

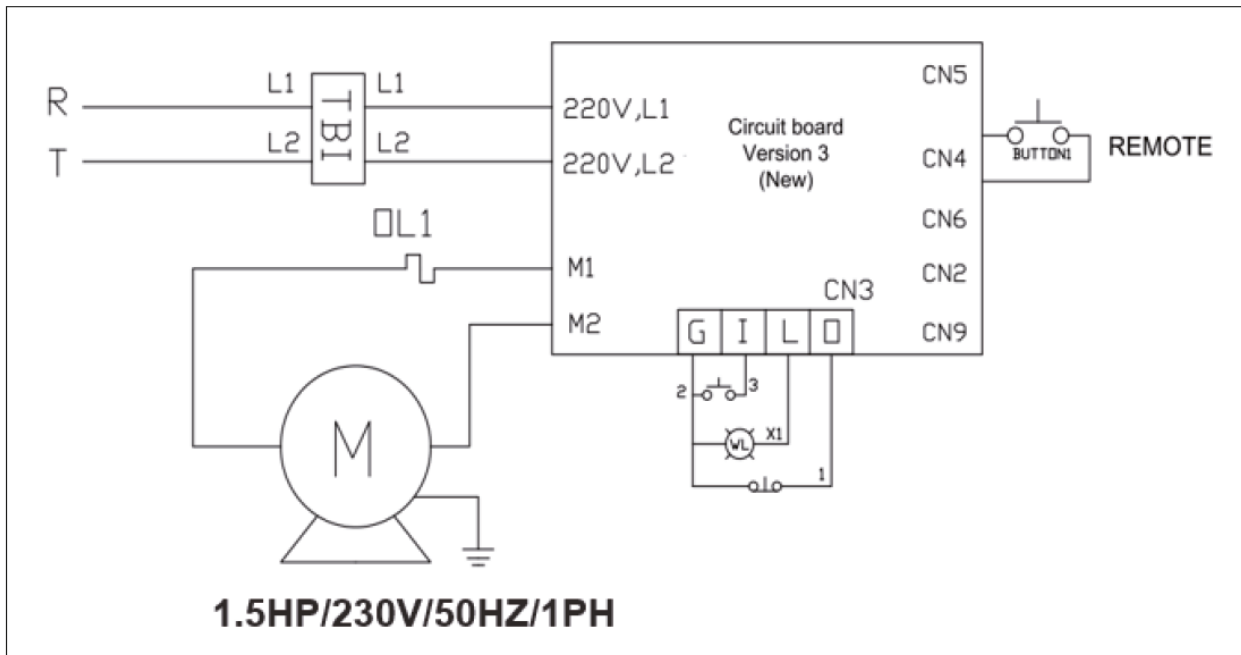

Control panel

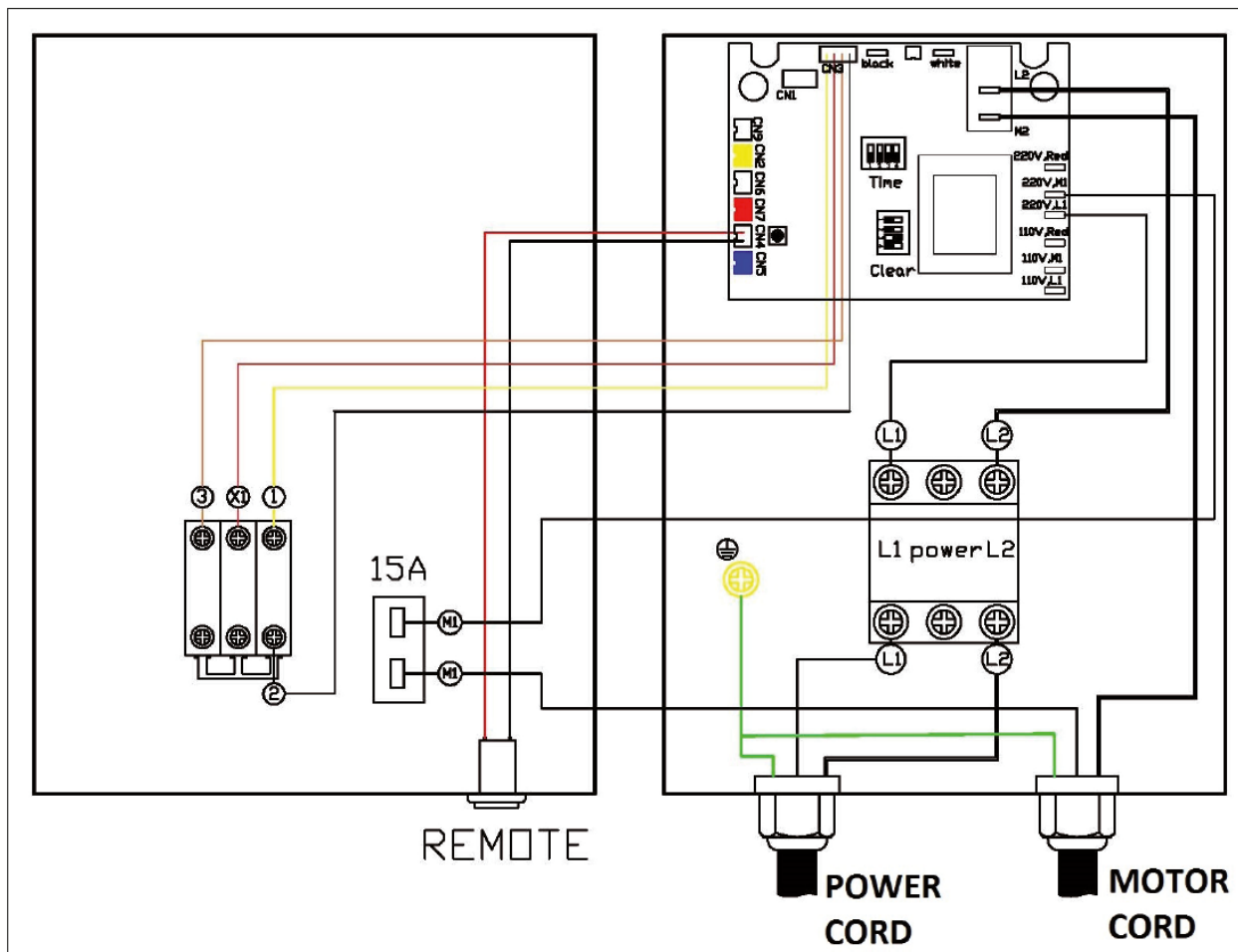



## 10. Parts List

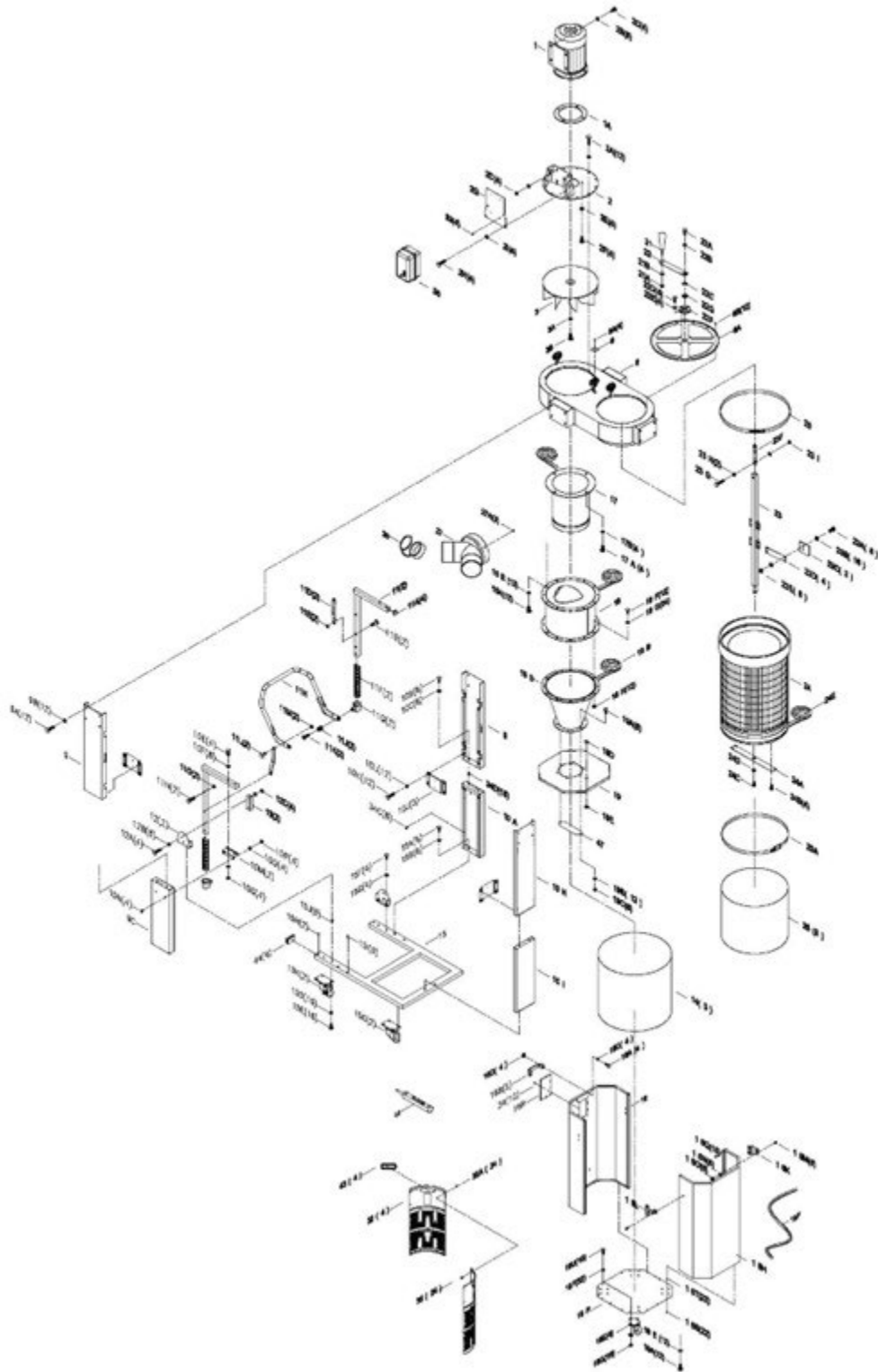





Cyclone and filter

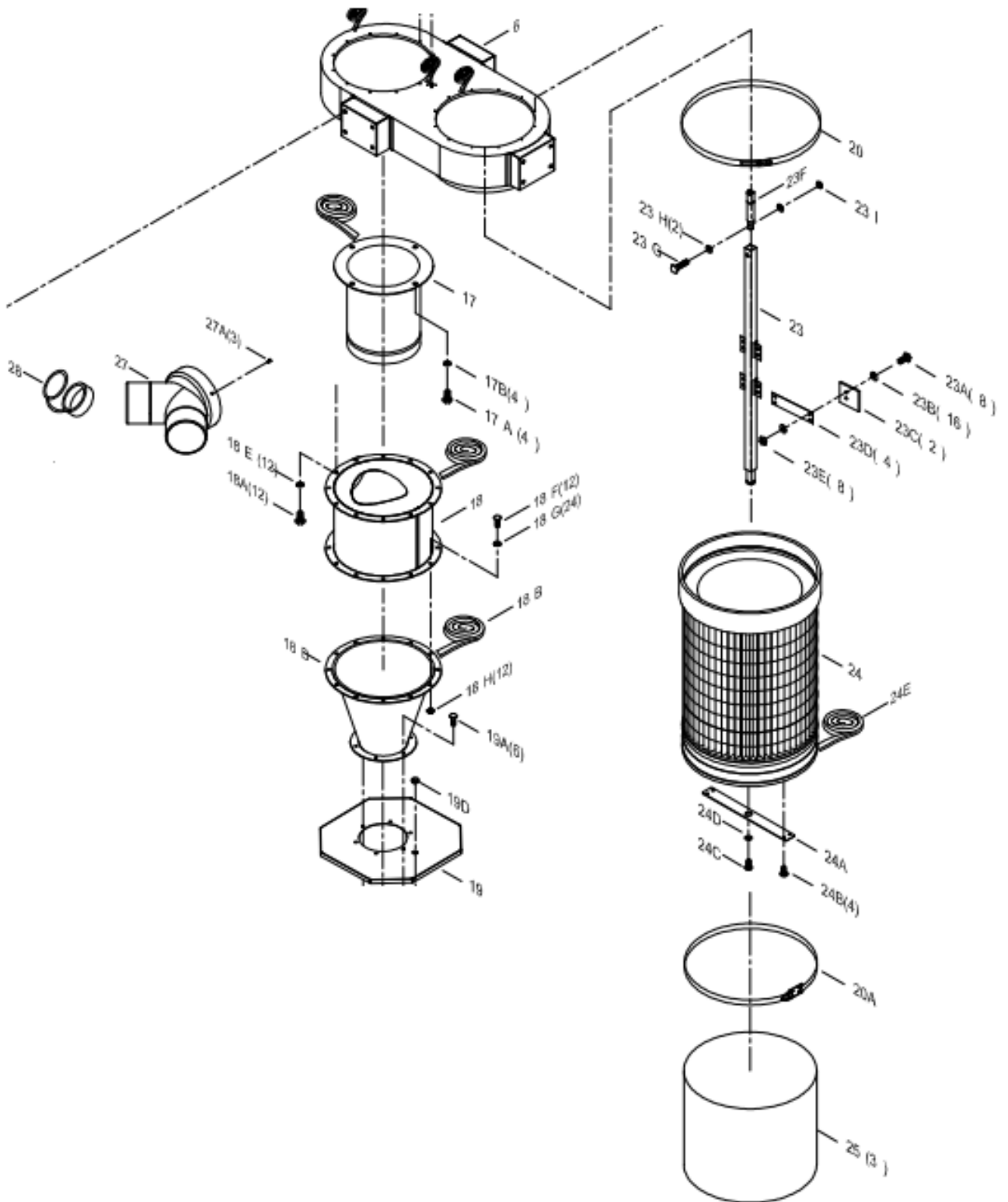

### Lifting mechanism

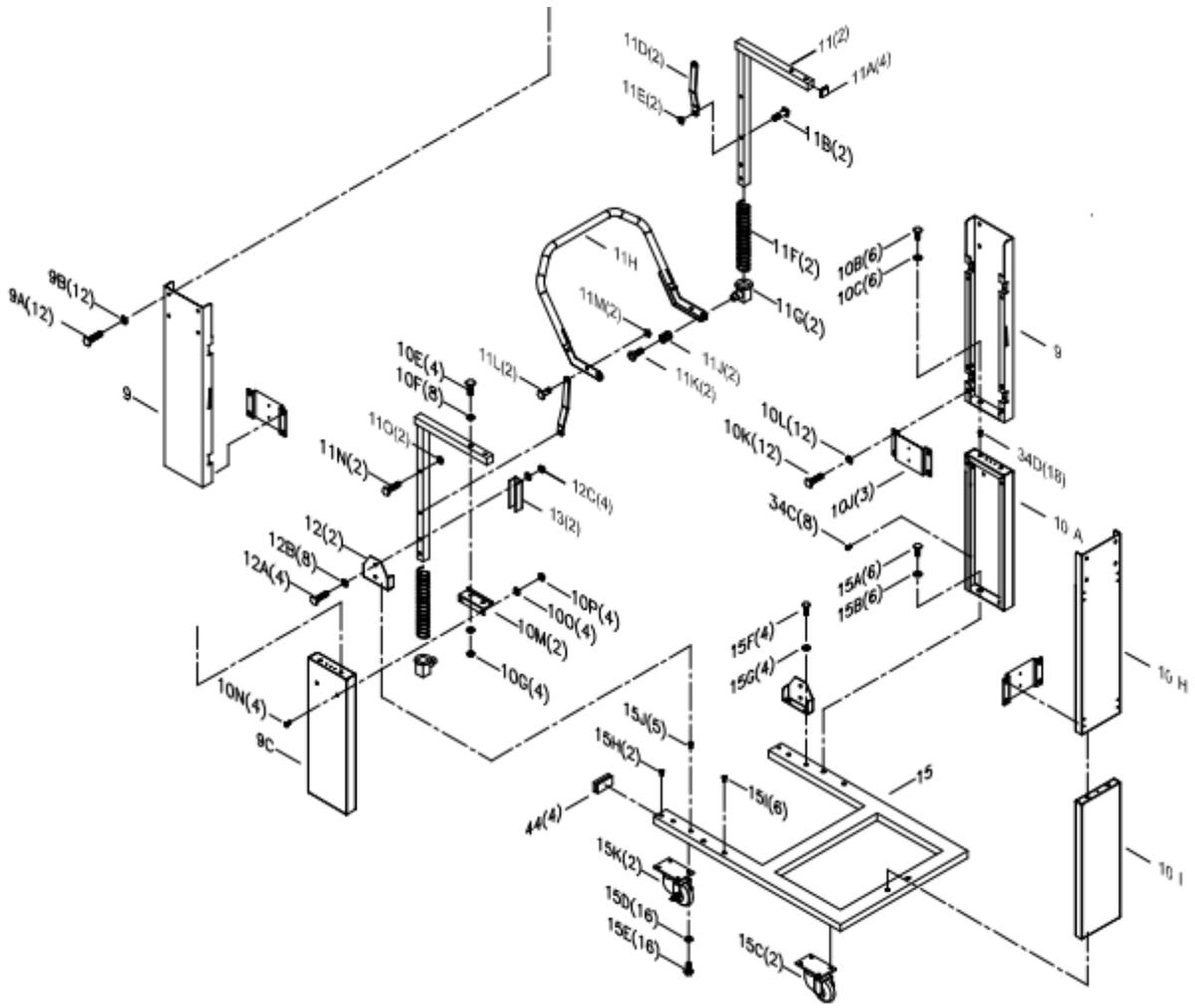

### Waste container

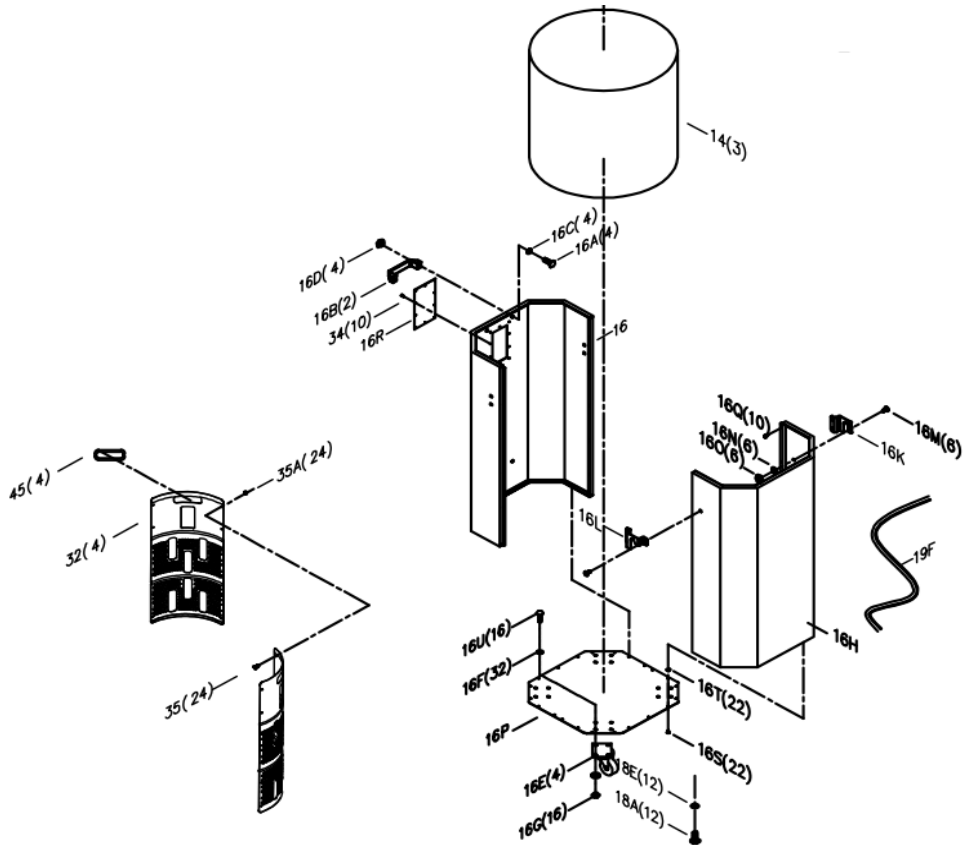

REF #	PART NUMBER	PART NAME	DESCRIPTION	QTY
16U	PDCCF15110-16U	HEX BOLT	5/16" x 3/4"	16
16F	PDCCF15110-16F	FLAT WASHER	5/16" x 3/4"	32
16G	PDCCF15110-16G	HEX NUT	5/16"	16
16H	PDCCF15110-16HV2	OCTAGON DRUM BACK PANEL		1
16K	PDCCF15110-16K	LEFT SIDE PLATE		1
16L	PDCCF15110-16L	RIGHT SIDE PLATE		1
16M	PDCCF15110-16M	CARRIAGE BOLT	1/4" x 1/2"	6
16N	PDCCF15110-16N	FLAT WASHER	1/4" x 1"	6
16O	PDCCF15110-16O	HEX NUT	1/4"	6
16P	PDCCF15110-16PV2	OCTAGON DRUM BASE PANEL		1
16R	PDCCF15110-16R	WINDOW		1
16S	PDCCF15110-16SV2	SHEET METAL SCREWS	M4	22
16T	PDCCF15110-16TV2	PLASTIC BOLT END CAP	M4	22
16Q	PDCCF15110-16Q	THREAD BOLT	M4 x 12mm	10
17	PDCCF15110-17	INTAKE CYLINDER		1
17A	PDCCF15110-17A	HEX BOLT	5/16" x 5/8"	4
17B	PDCCF15110-17B	FLAT WASHER	5/16" x 3/4"	4
18	PDCCF15110-18	CYCLONE BARREL	5/16" x 3/4"	1
18A	PDCCF15110-18A	HEX BOLT	5/16" x 3/4"	12
18B	PDCCF15110-18B	FOAM TAPE	3 x 6mm x 10M	1
18D	PDCCF15110-18D	CYCLONE FUNNEL		1
18E	PDCCF15110-18E	FLAT WASHER	5/16" x 3/4"	12
18F	PDCCF15110-18F	HEX BOLT	5/16" x 3/4"	12
18G	PDCCF15110-18G	FLAT WASHER	5/16" x 3/4"	24
18H	PDCCF15110-18H	HEX NUT	5/16"	12
19	PDCCF15110-19	OCTAGON DRUM LID		1
19A	PDCCF15110-19A	HEX BOLT	5/16" x 3/4"	6
19B	PDCCF15110-19B	FLAT WASHER	5/16" x 3/4"	12
19C	PDCCF15110-19C	HEX NUT	5/16"	6
19D	PDCCF15110-19D	PLUG	MSP-16	1
19E	PDCCF15110-19E	NUT	AGL-16	1
19F	PDCCF15110-19F	RUBBER GASKET	1400mm	1
20	PDCCF15110-20	BAND CLAMP	Ø 400mm	1
20A	PDCCF15110-20A	SPRING BAND CLAMP	Ø 400mm	1
21	PDCCF15110-21	ROTATION HANDLE		1
21A	PDCCF15110-21A	HEX LOCK NUT	3/8"	1
21B	PDCCF15110-21B	FLAT WASHER	3/8" x 7/8"	1
22	PDCCF15110-22	ROTATION CRANK	210, 35, 4.5t	1
22A	PDCCF15110-22A	HEX BOLT	5/16" x 3/4"	1
22B	PDCCF15110-22B	FLAT WASHER	5/16" x 1-3/16"	1
22C	PDCCF15110-22C	GEAR	Ø20mm	1
22D	PDCCF15110-22D	HEX BOLT	1/4" x 3/4"	4
22E	PDCCF15110-22E	FLAT WASHER	1/4" x 3/4"	4
22F	PDCCF15110-22F	BEARING	Ø70, Ø20.5, 7t	1
22G	PDCCF15110-22G	SEAL		1
23	PDCCF15110-23V2	ROTATION SHAFT		1

23A	PDCCF15110-23A	HEX BOLT	1/4" x 5/8"	8
23B	PDCCF15110-23B	FLAT WASHER	1/4" x 1/2"	16
23C	PDCCF15110-23C	PADDLE		2
23D	PDCCF15110-23D	PADDLE BRANCH		4
23E	PDCCF15110-23E	HEX LOCK NUT	1/4"	8
23F	PDCCF15110-23F	ROTATION SHAFT CONNECTION		1
23G	PDCCF15110-23G	HEX BOLT	5/16" x 1-1/2"	1
23H	PDCCF15110-23H	FLAT WASHER	5/16" x 3/4"	2
23I	PDCCF15110-23I	HEX LOCK NUT	5/16"	1
24	PDCCF15110-24	CANISTER FILTER	Ø 400x500mm L	1
24A	PDCCF15110-24A	ROTATION SHAFT BASE		1
24B	PDCCF15110-24B	SHEET METAL PHILIPS BOLT	3/16" x 3/4"	4
24C	PDCCF15110-24C	HEX BOLT	5/16" x 3/4"	1
24D	PDCCF15110-24D	FLAT WASHER	5/16" x 7/8"	1
24E	PDCCF15110-24E	FOAM TAPE	3 x 25mm x 1.5M	1
25	PDCCF15110-25	PLASTIC BAG	Ø 400 x 600mm	3
27	PDCCF15110-27	INTAKE MANIFOLD	6"X1 / 4"X2 ports	1
27A	PDCCF15110-27A	SHEET METAL BOLT	M4 x 12mm	3
28	PDCCF15110-28	RUBBER CAP	4"	1
32	PDCCF15110-32	DRUM INSERT		4
33	PDCCF15110-33	FLAT HEAD BOLT	M4 x 6mm	4
34	PDCCF15110-34	RIVET	03.II	10
34A	PDCCF15110-34A	FLAT WASHER	1/8" x 5/16"	6
34C	PDCCF15110-34C	RIVET NUT	1/4"	8
34D	PDCCF15110-34D	RIVET NUT	5/16"	18
35	PDCCF15110-35	ROUND HD BOLT	3/16" x 1/2"	24
35A	PDCCF15110-35A	NUT	3/16"	24
36	PDCCF15110-36V2	FREQUENCY REMOTE SWITCH		1
44	PDCCF15110-44	RUBBER PLUG	30 x 60mm	4
45	PDCCF15110-45	RUBBER HANDLE FOR DRUM INSERT		4
46	PDCCF15110-46	SILICONE	Tube	1
47	PDCCF15110-47	CROSSBAR		1